

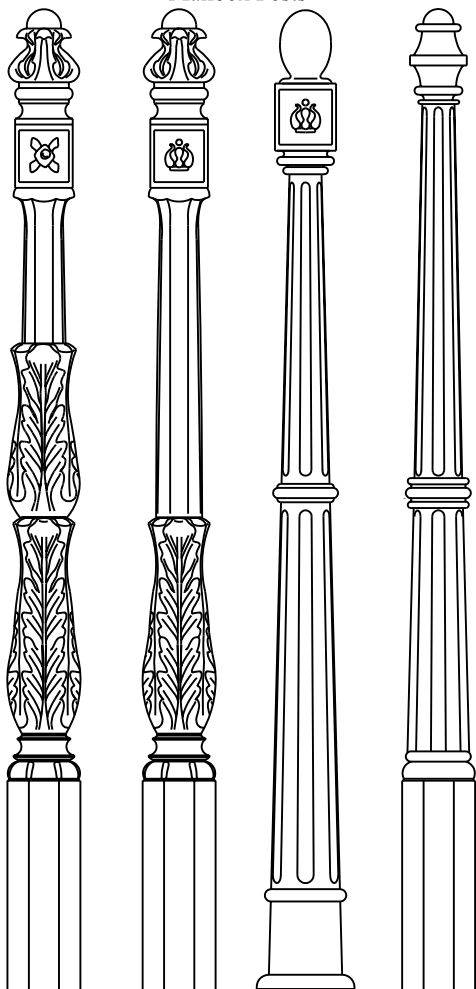

IMPERIAL MAILBOX SYSTEMS

"IMPERIAL SERIES" CAST ALUMINUM MAILBOX SYSTEMS COMPONENT SHEET

Mailbox Posts



Post 1 Post 2 Post 3 Post 5

Mailboxes

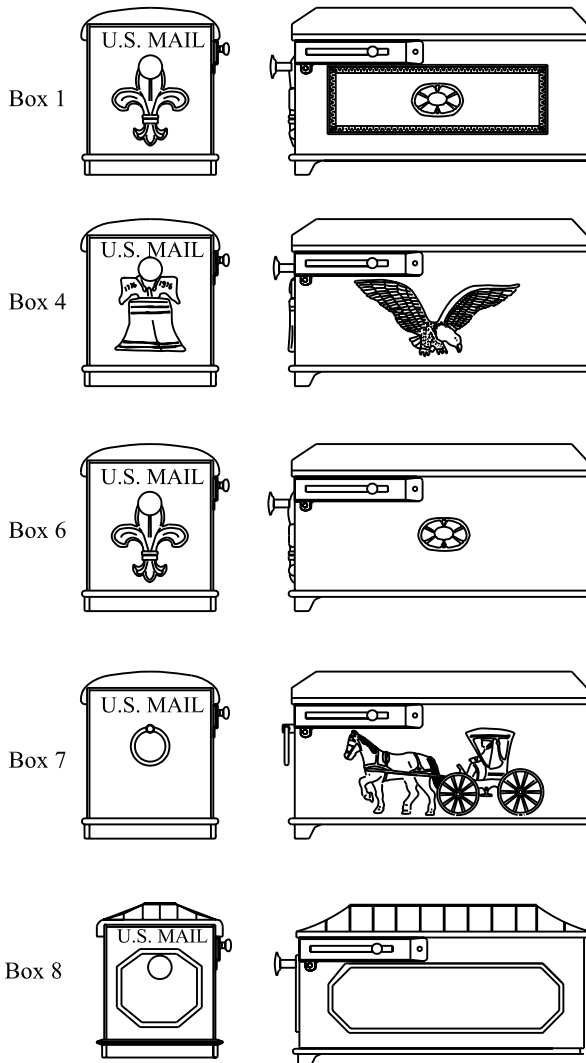

Box 1

Box 4

Box 6

Box 7

Box 8

Mailbox Accessories

Number Plate

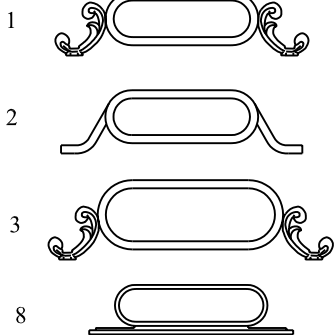

Scroll Support
Brace

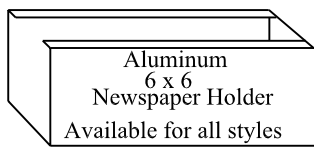

Aluminum
6 x 6
Newspaper Holder
Available for all styles

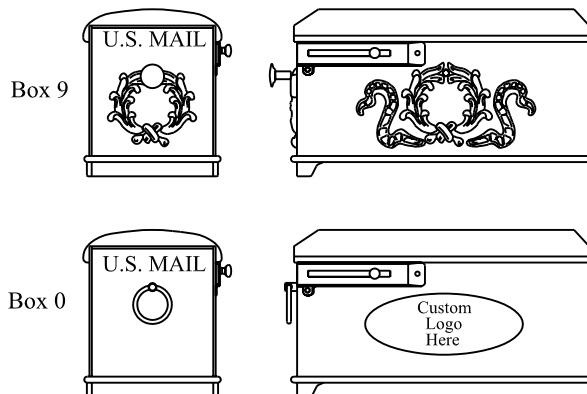

Box 9

Box 0

800-647-0777

FAX: 334-285-6635

ALL MAILBOXES EQUIPPED WITH KNOB
OR RING PULL FOR FRONT DOOR

www.imperialmailboxsystems.com



IMPERIAL MAILBOX SYSTEMS

HOW TO ORDER "IMPERIAL SERIES" MAILBOX SYSTEMS

SYSTEM CODE SPECIFICATION

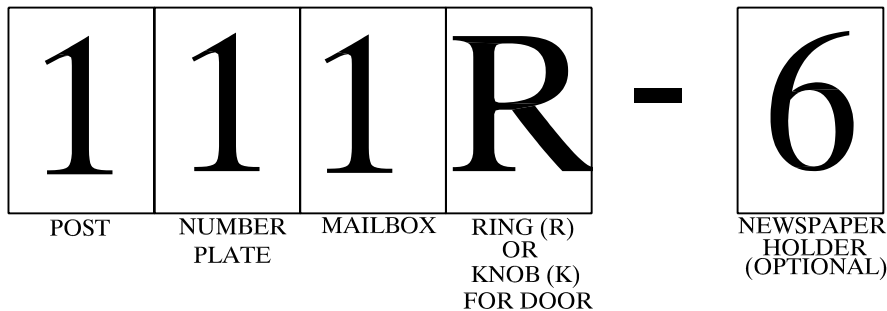

SYSTEM RENDERING FROM CODE SPECIFIED ABOVE:

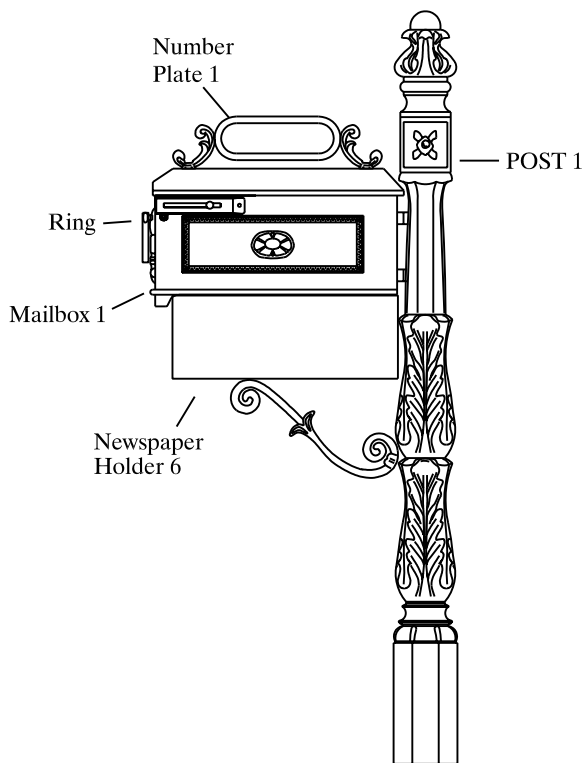

-ALL SYSTEMS INCLUDE
"S" SCROLL SUPPORT BRACE

-MAILBOX 8 AND NUMBER
PLATE 8 CAN ONLY BE USED
TOGETHER. EXAMPLE:

(388K) (~~328K~~) (~~384K~~)

1 2 3 4 5 6 7 8 9 0

-2" BRASS NUMBERS AVAILABLE
FOR NUMBER PLATES 1, 2, AND 8.

-3" BRASS NUMBERS AVAILABLE
FOR NUMBER PLATE 3



IMPERIAL MAILBOX SYSTEMS

"IMPERIAL SERIES" MAILBOX SYSTEMS FEATURING POST 1 AND POST 2

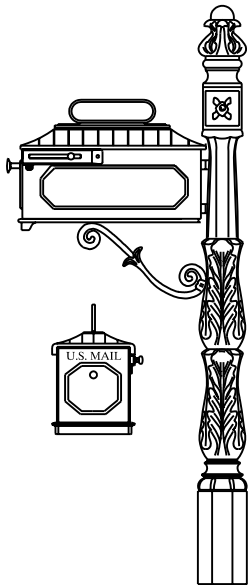

188K

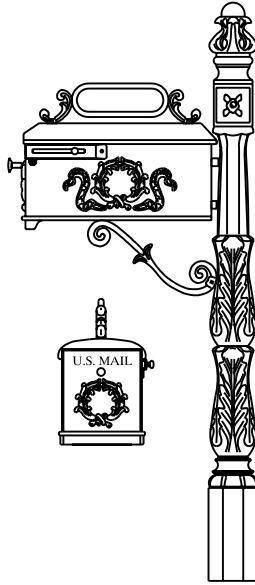

119K

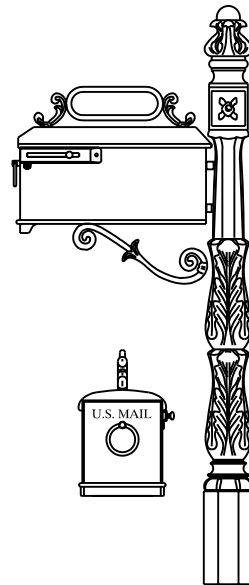

110R

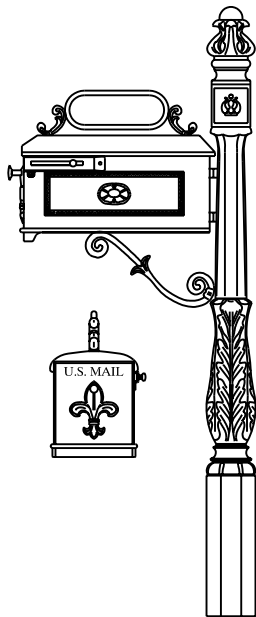

231K

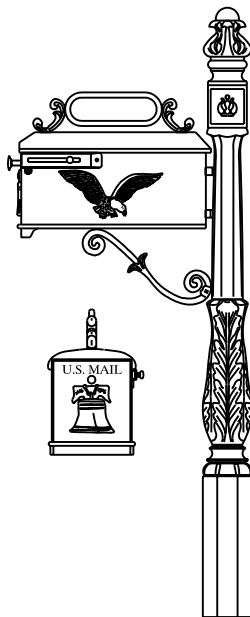

214K

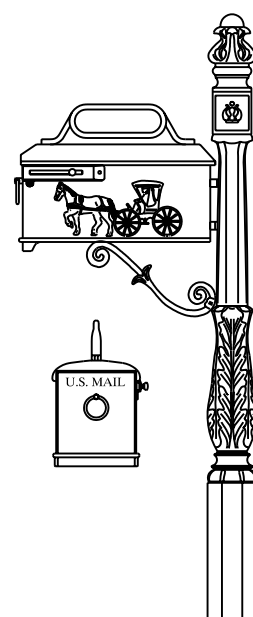

227R

800-647-0777

FAX: 334-285-6635

www.imperialmailboxsystems.com



IMPERIAL MAILBOX SYSTEMS

"IMPERIAL SERIES" MAILBOX SYSTEMS FEATURING POST 3 AND POST 5

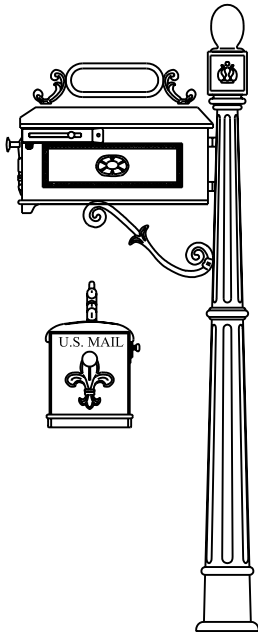

311K

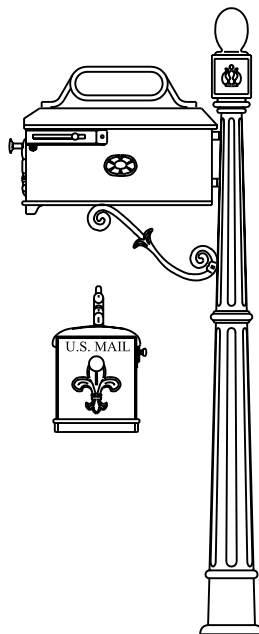

326K

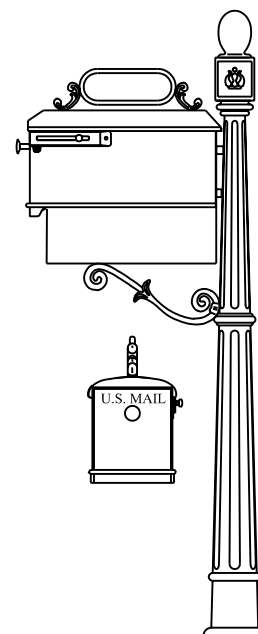

310K-6

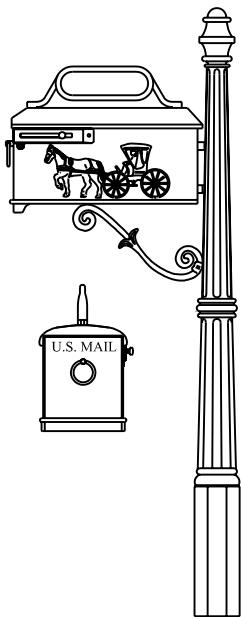

527R

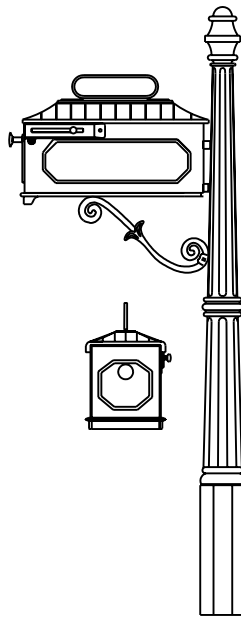

588K

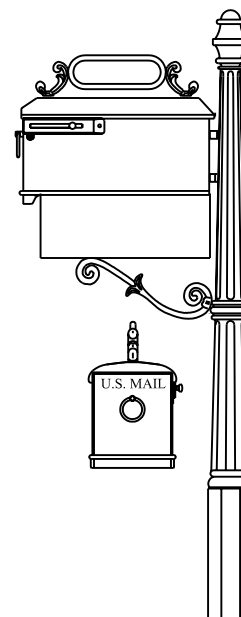

510R-6

800-647-0777

FAX: 334-285-6635

www.imperialmailboxsystems.com



IMPERIAL MAILBOX SYSTEMS

"ESTATE SERIES" MAILBOX SYSTEMS FEATURING POST 6

SYSTEM CODE SPECIFICATION

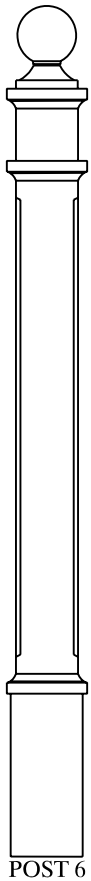
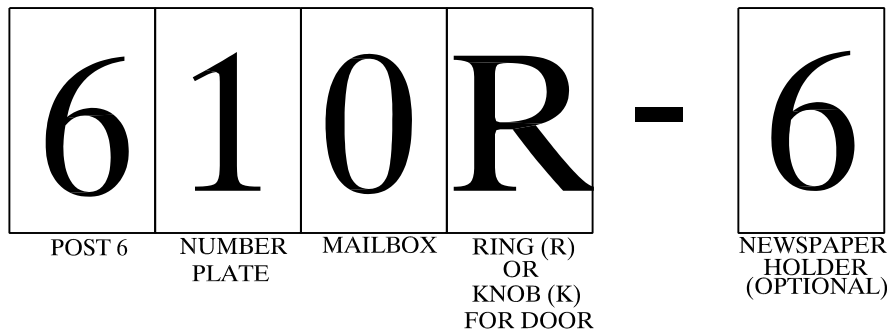

The impressive design of the "Estate Series" mailbox system adds grandeur to any home or community. All mailbox and number plate combinations available for "Imperial Series" are also available for "Estate Series" systems.

All "Estate Series" mailbox systems feature the "C" scroll support brace.

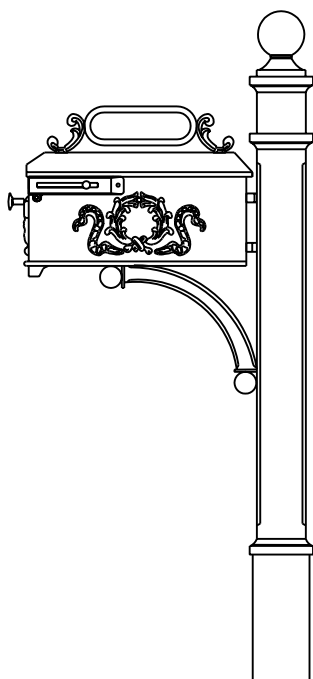
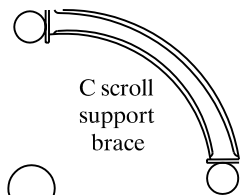

619K

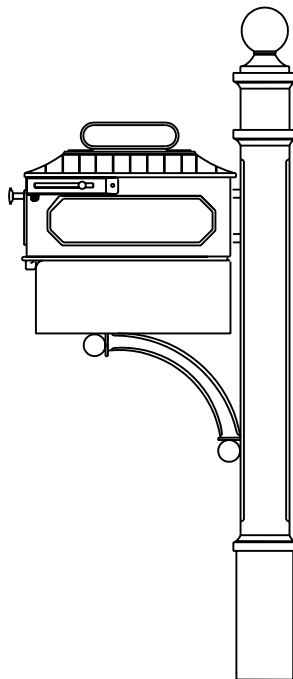

688K-6

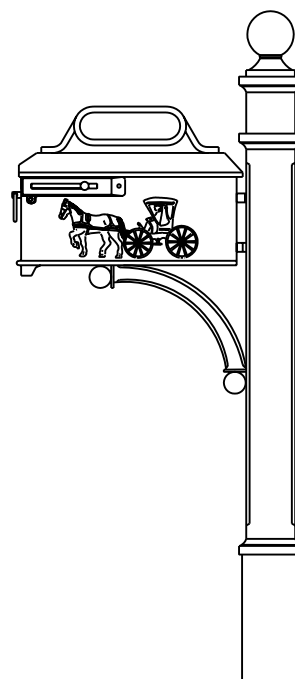

627R



IMPERIAL MAILBOX SYSTEMS

"WINDSOR SERIES" MAILBOX SYSTEMS FEATURING POST 7

SYSTEM CODE SPECIFICATION

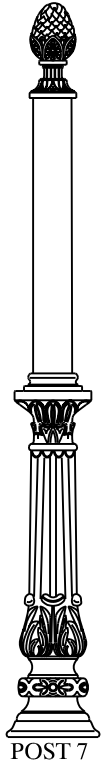
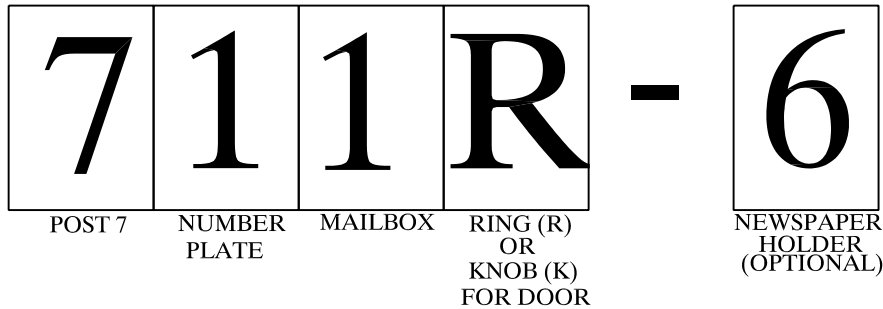

POST 7

The Windsor Series, featuring Post 7 combines a traditional mailbox design with a Corinthian style.

All mailbox and number plate combinations available for "Imperial Series" systems are also available for "Windsor Series" systems.

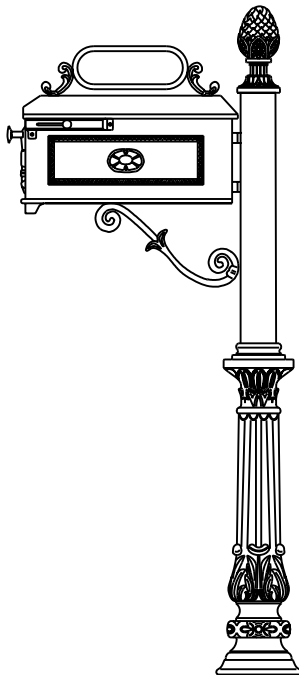

731K

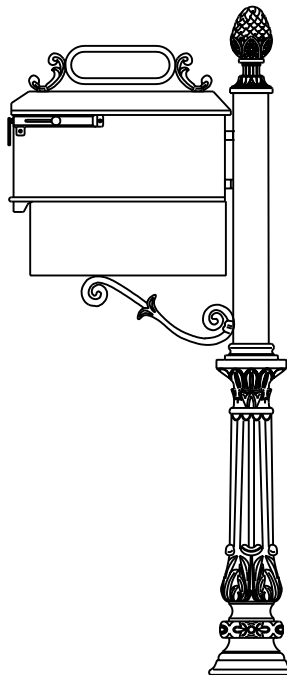

710R-6

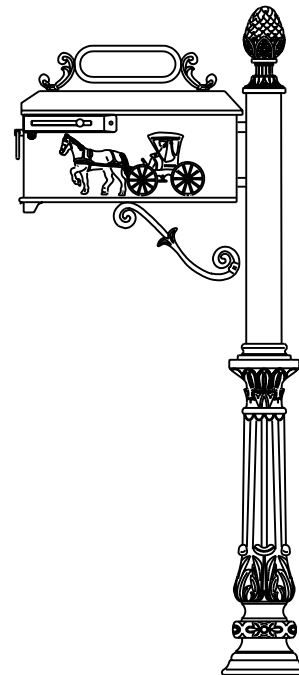

717R



IMPERIAL MAILBOX SYSTEMS

"CENTURY SERIES" MAILBOX SYSTEMS FEATURING POST 8

SYSTEM CODE SPECIFICATION

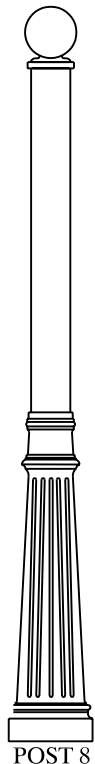
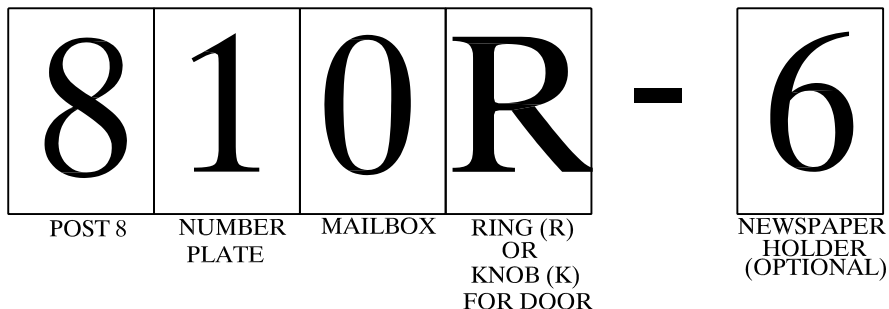

The Century Series, featuring Post 8 combines a traditional mailbox design with a contemporary style.

All mailbox and number plate combinations available for "Imperial Series" systems are also available for "Century Series" systems.

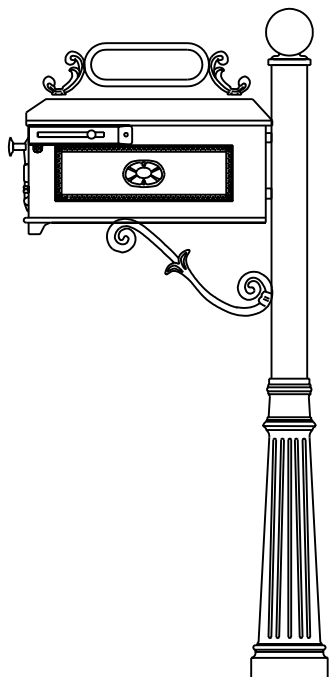

831K

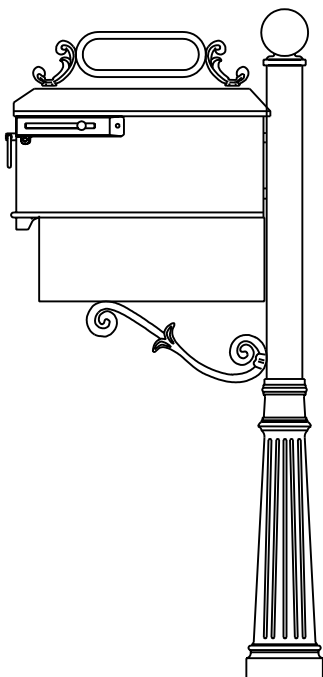

810R-6

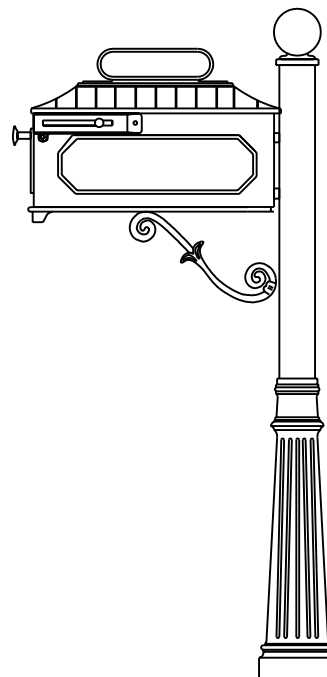

888K



IMPERIAL MAILBOX SYSTEMS

"ESTATE SERIES" MAILBOX SYSTEMS FEATURING POST 6 AND EXTRA-LARGE ESTATE MAILBOX

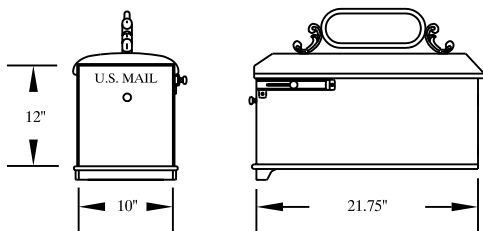

ESTATE SERIES MAILBOXES
ARE 45% LARGER THAN STANDARD
IMPERIAL MAILBOXES

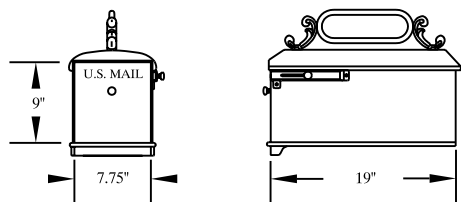

STANDARD IMPERIAL MAILBOX

SYSTEM CODE SPECIFICATION

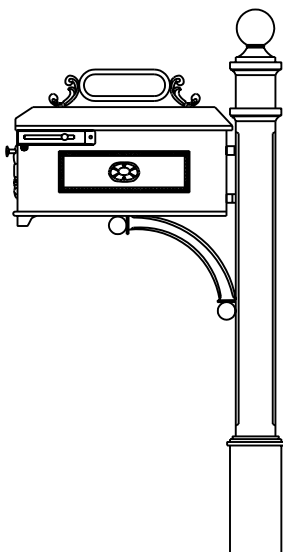
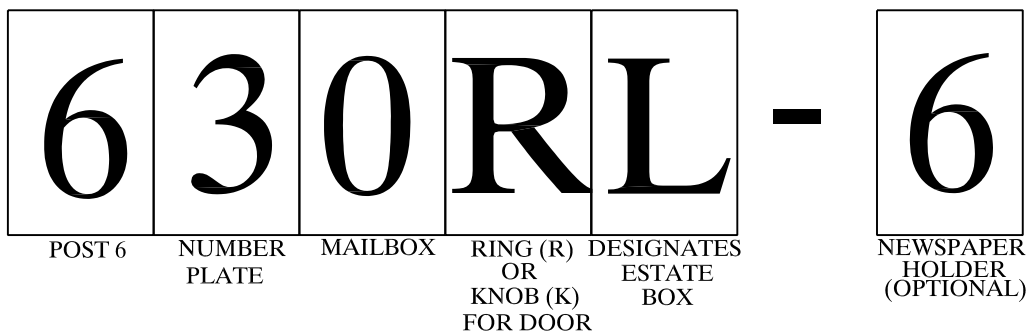

631KL

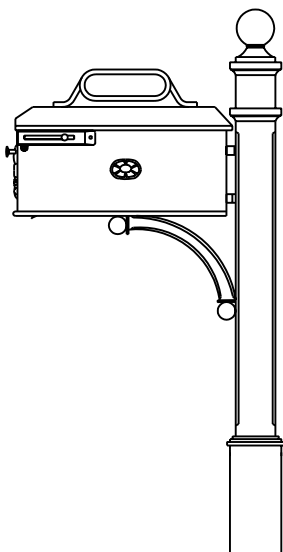

626KL

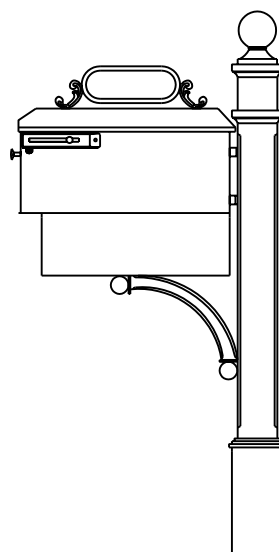

630KL-6

800-647-0777

FAX: 334-285-6635

www.imperialmailboxsystems.com



IMPERIAL MAILBOX SYSTEMS

"TWIN" CAST ALUMINUM MAILBOX SYSTEMS FEATURES TWO MAILBOXES ON ONE POST

SYSTEM CODE SPECIFICATION

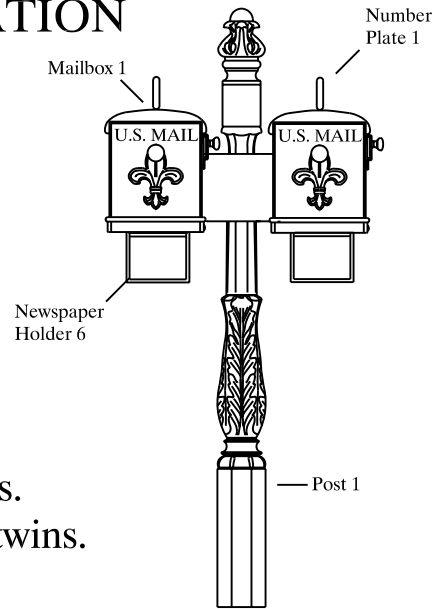
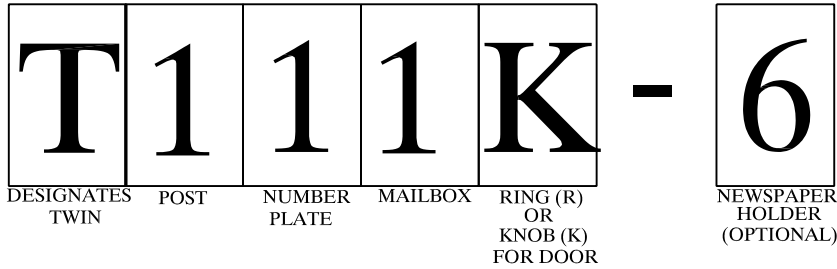

Twin systems are available with Imperial Series, Century Series, and Estate Series Mailbox Systems. Extra-large Estate mailboxes are not available as twins.

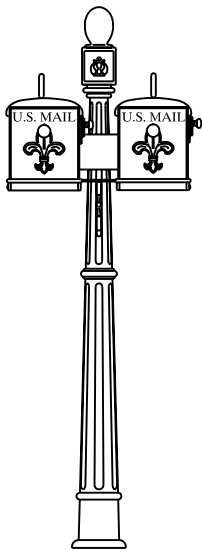

T321K

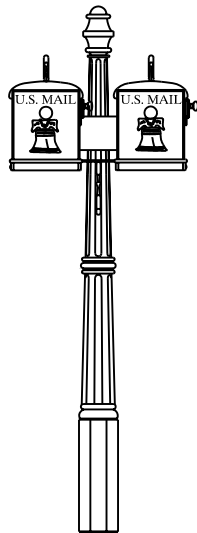

T514K

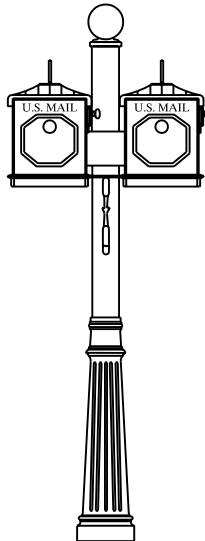

T888K

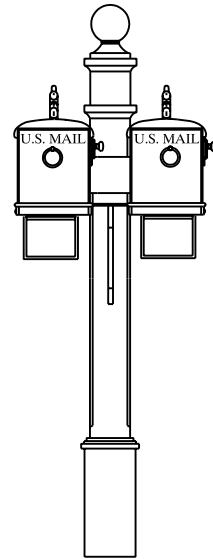

T630R-6



IMPERIAL MAILBOX SYSTEMS

IMPERIAL POST SYSTEMS COMPONENT SHEET

Imperial post systems feature a decorative post and brace combination with your choice of base and finial styles. They are designed for use with standard, Post Office approved rural mailboxes.

POSTS

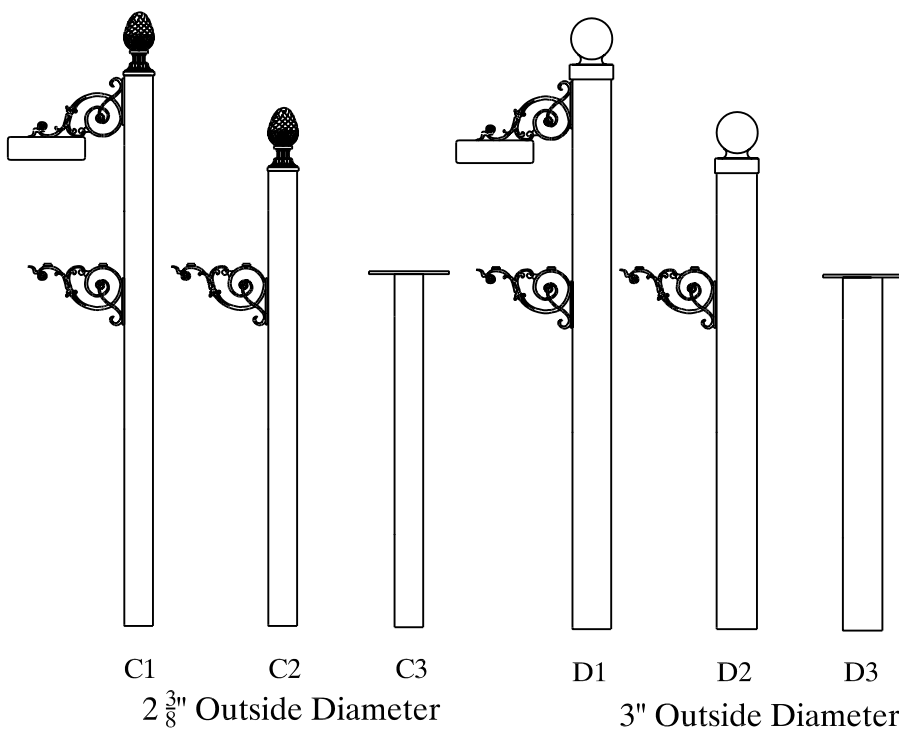

BASES

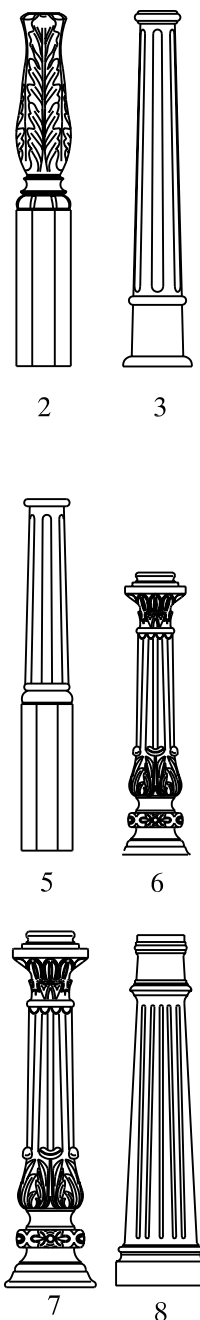

FINIALS

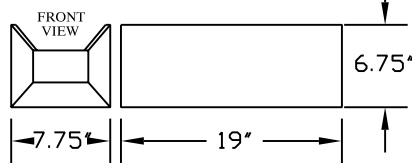
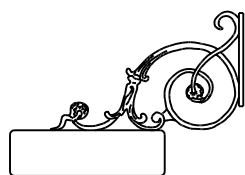
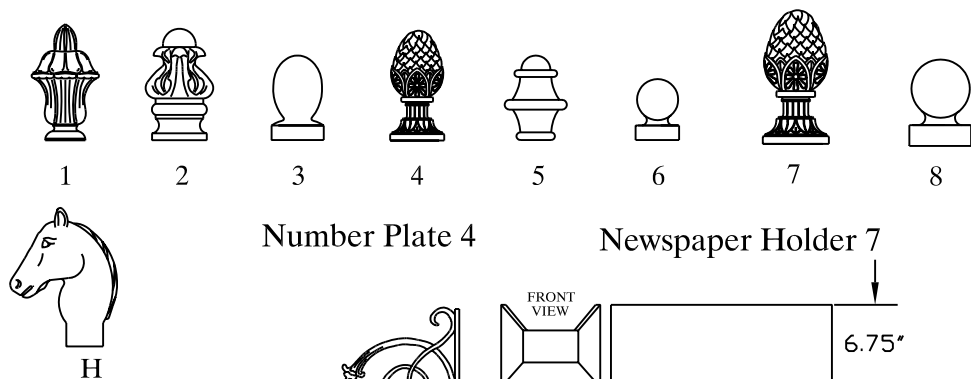

Designed for use with large size rural mailboxes

Base 7-8 and Finial 7-8 are only available in "D" series posts.



IMPERIAL MAILBOX SYSTEMS

HOW TO ORDER "C" AND "D" SERIES POST SYSTEMS.

SYSTEM CODE SPECIFICATION

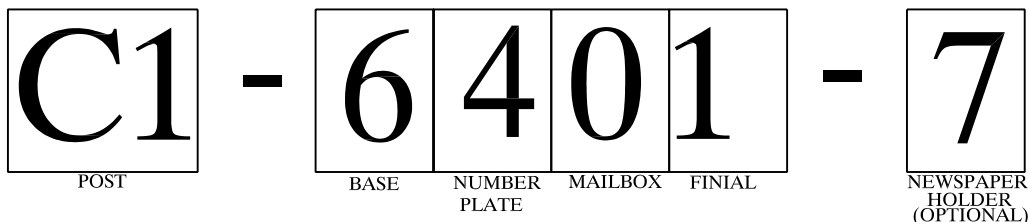

SYSTEM RENDERING FROM
CODE SPECIFIED ABOVE:

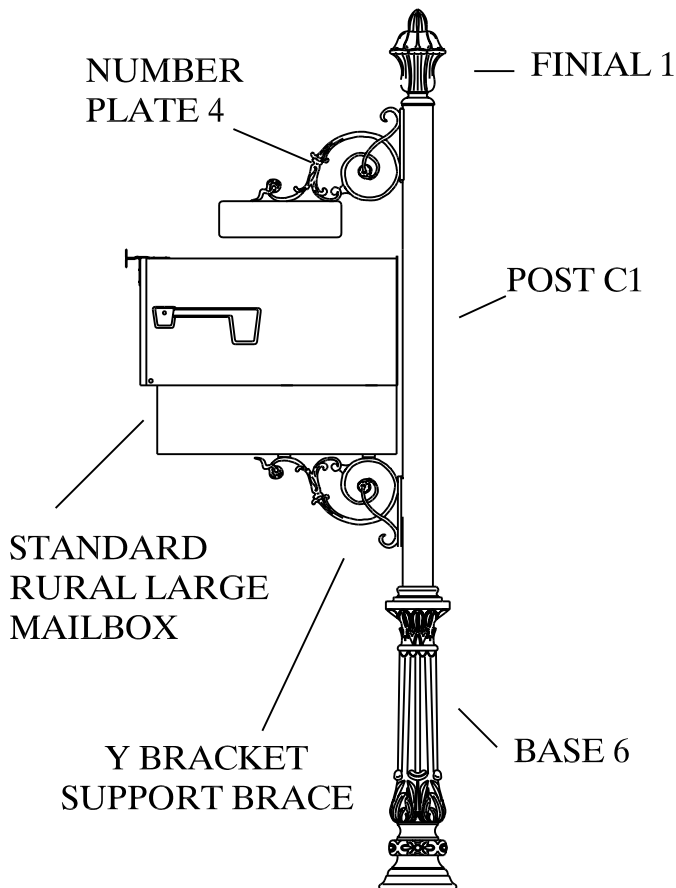

-NUMBER PLATE 4 IS
FEATURED ON C1 AND D1
POSTS.

-C2, D2, C3, AND D3 SERIES
POST SYSTEMS ARE
AVAILABLE WITH NUMBER
PLATE 1, 2, OR 3. (SEE PAGE 1)

-ALL BRASS NUMBERS SHOWN
ON PAGE 4 ARE AVAILABLE
FOR NUMBER PLATES. 2" OR
3" BRASS NUMBERS CAN BE
USED ON NUMBER PLATE 4.



IMPERIAL MAILBOX SYSTEMS

CLASSIC POST SYSTEMS

Featuring C1 or D1 posts with the base and finial combination of your choice.

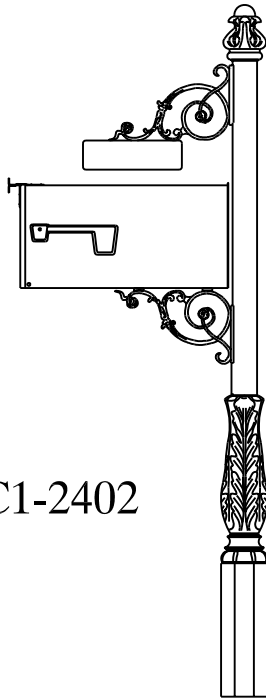

C1-2402

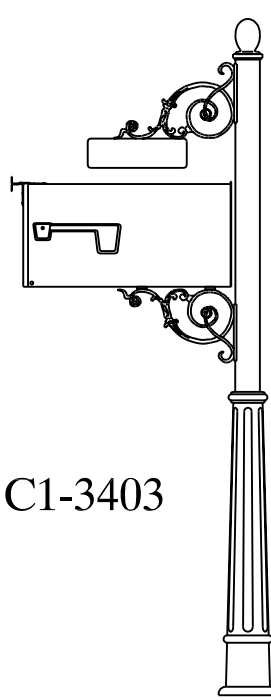

C1-3403

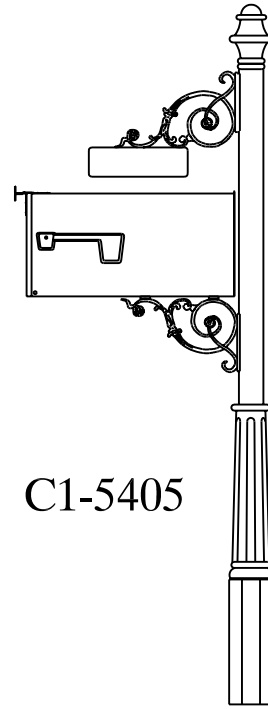

C1-5405

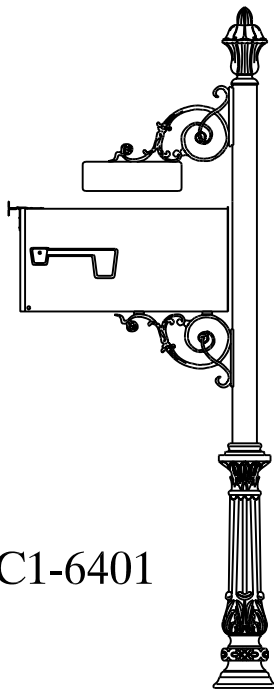

C1-6401

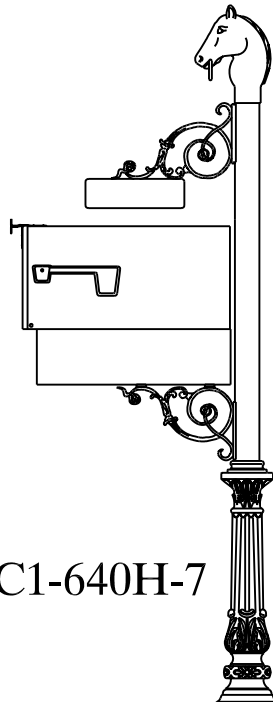

C1-640H-7

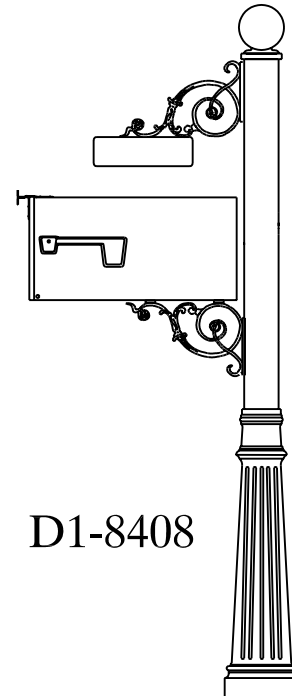

D1-8408



IMPERIAL MAILBOX SYSTEMS

CONTEMPORARY POST SYSTEMS

Featuring C2 or D2 posts with the base and final combination of your choice.

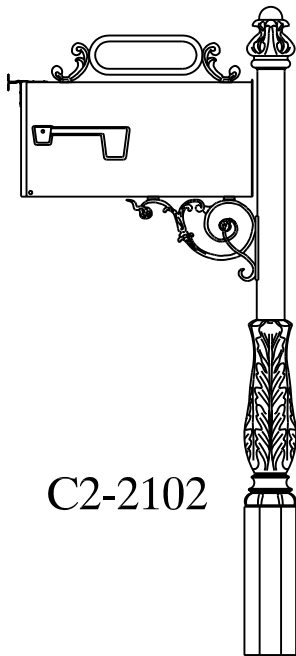

C2-2102

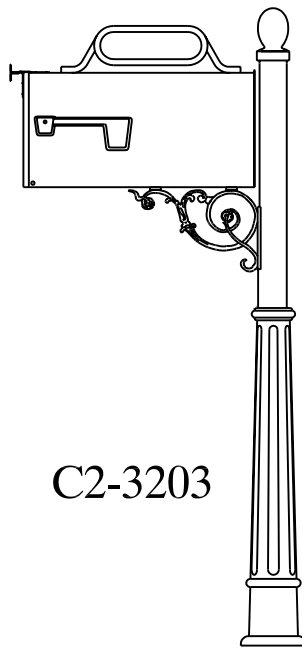

C2-3203

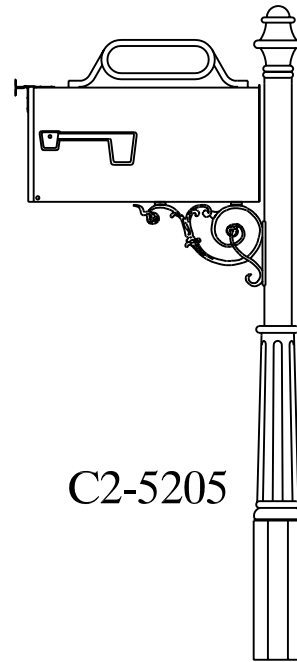

C2-5205

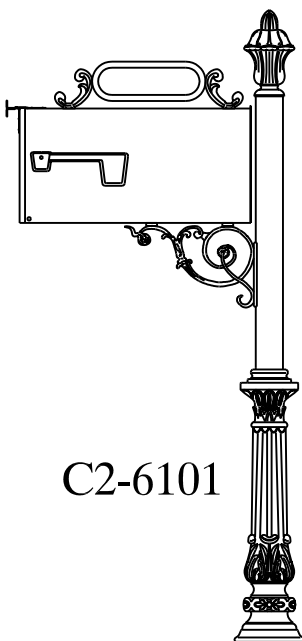

C2-6101

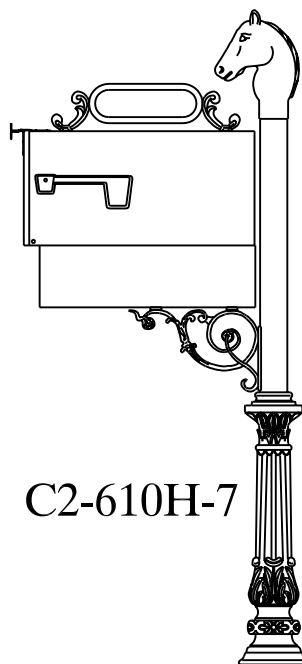

C2-610H-7

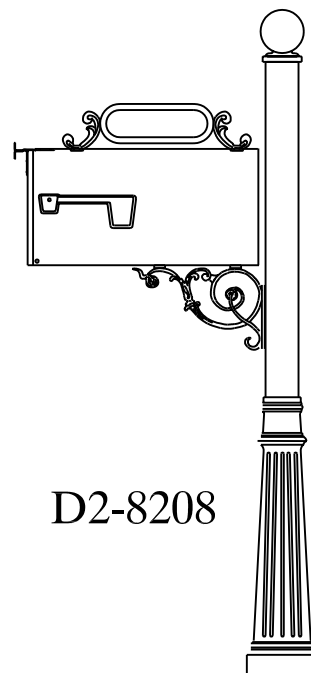

D2-8208



IMPERIAL MAILBOX SYSTEMS

MILLBROOK POST SYSTEMS

Featuring C3 or D3 posts with the base and finial combination of your choice.

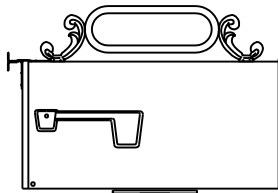

C3-2100

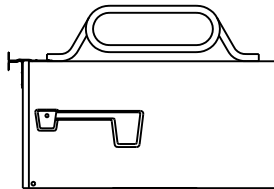

C3-3200

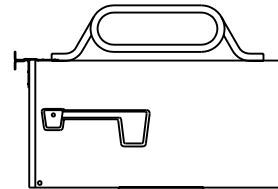
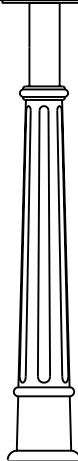

C2-5200

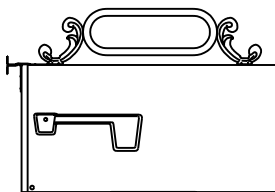
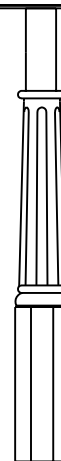

C3-6100

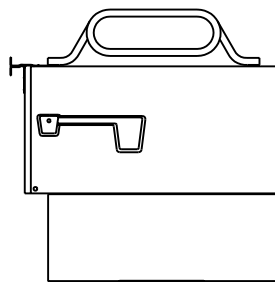
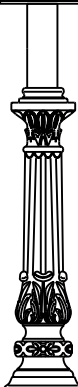

C3-2200-7

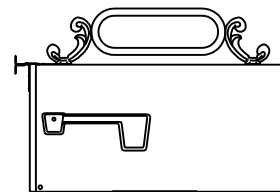

D3-8100





IMPERIAL MAILBOX SYSTEMS

HOW TO ORDER "D" SERIES POST SYSTEMS FEATURING THE NEW BASE AND FINIAL 7.

SYSTEM CODE SPECIFICATION

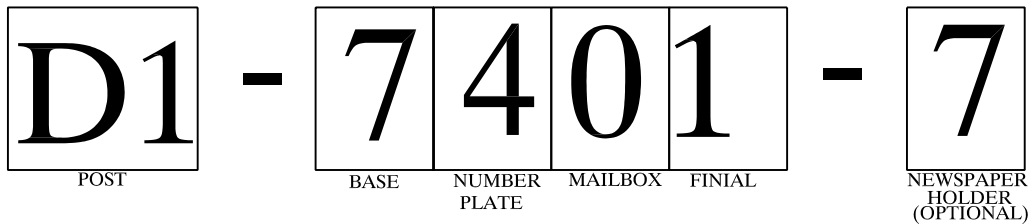

SYSTEM RENDERING FROM
CODE SPECIFIED ABOVE:

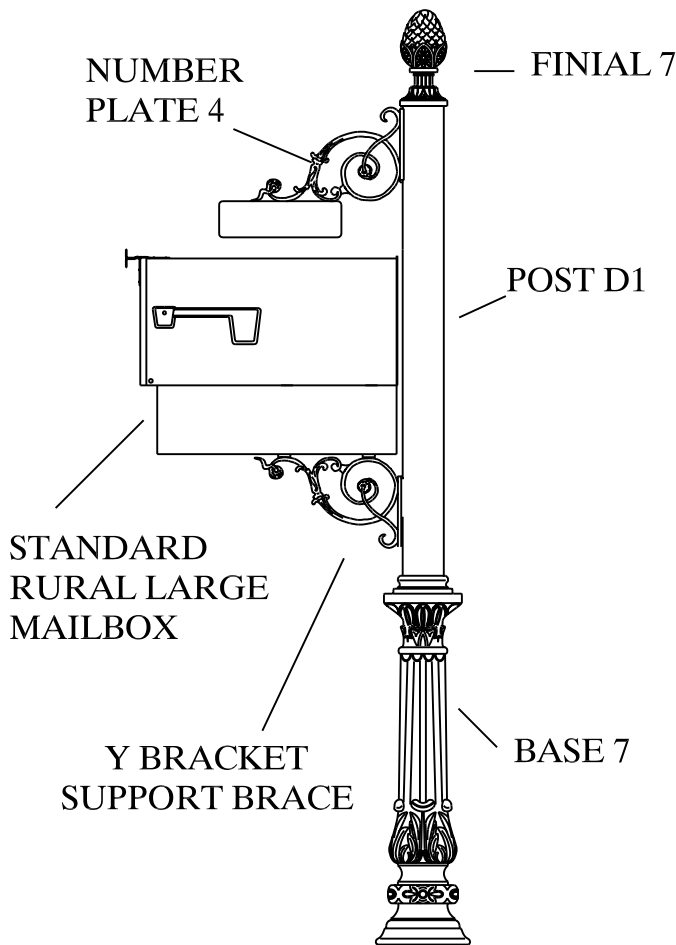

-NUMBER PLATE 4 IS
FEATURED ON D1 POSTS.

-D2 AND D3 SERIES POST
SYSTEMS ARE AVAILABLE
WITH NUMBER
PLATE 1, 2, OR 3.

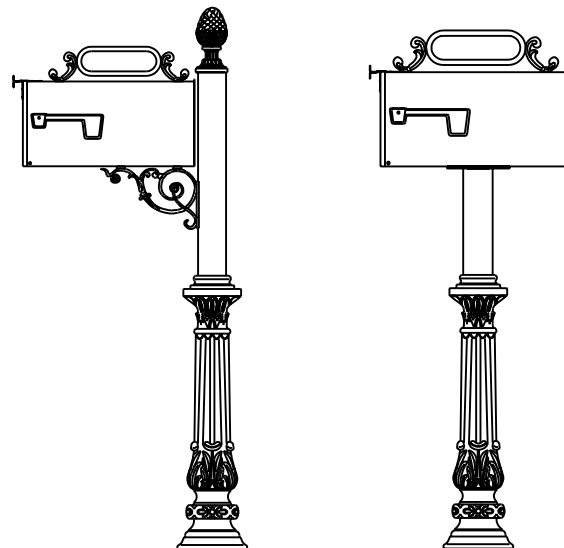

D2-7107

D3-7100

All poles have 3" OD

800-647-0777

FAX: 334-285-6635

www.imperialmailboxsystems.com



IMPERIAL MAILBOX SYSTEMS

TWIN IMPERIAL POST SYSTEMS

AVAILABLE WITH C2, D2, C3, AND D3 POSTS

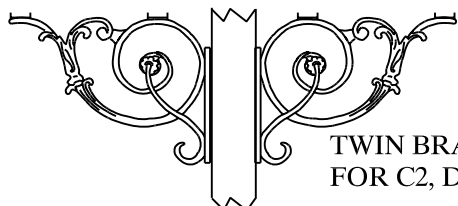

TWIN BRACKETS
FOR C2, D2 POLES

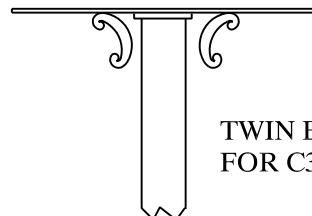

TWIN BRACKETS
FOR C3, D3 POLES

SYSTEM CODE SPECIFICATION

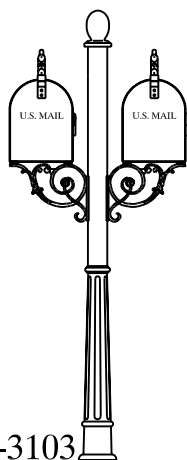
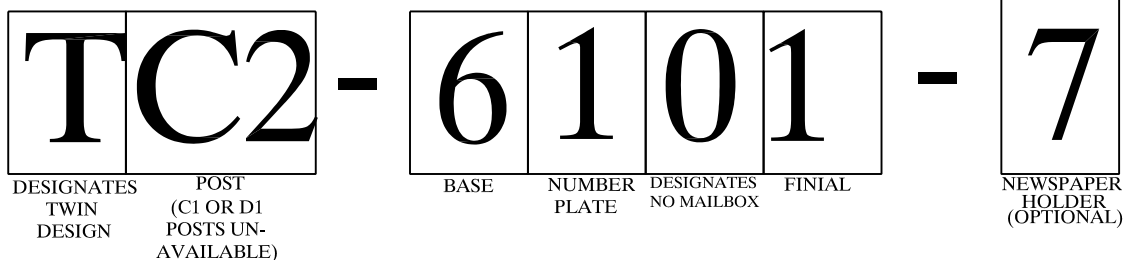

TC2-3103

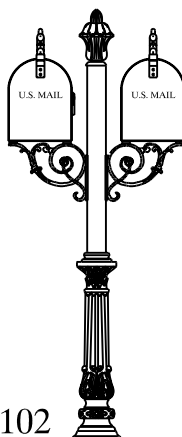

TC2-6102

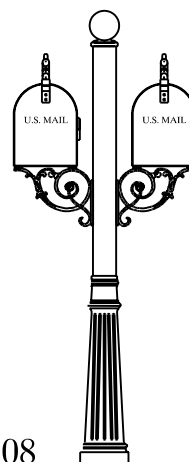

TC2-8108

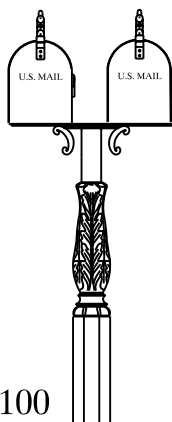

TC3-2100

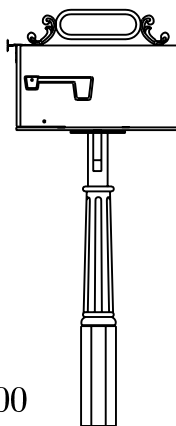

TC3-5100

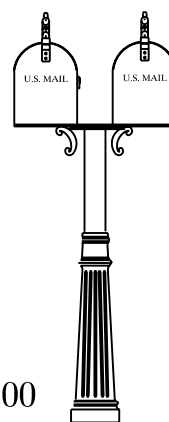

TD3-8100

800-647-0777

FAX: 334-285-6601

www.imperialmailboxsystems.com



IMPERIAL MAILBOX SYSTEMS

"CARSON SERIES" POST SYSTEMS

Features C3 or D3 posts with an Imperial mailbox 8.

SYSTEM CODE SPECIFICATION

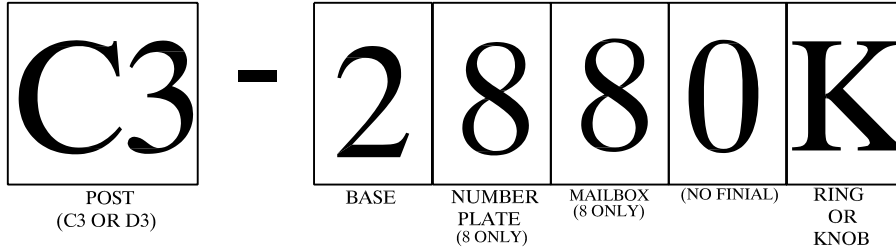

NEWSPAPER HOLDERS
ARE NOT AVAILABLE
FOR CARSON SERIES
SYSTEMS

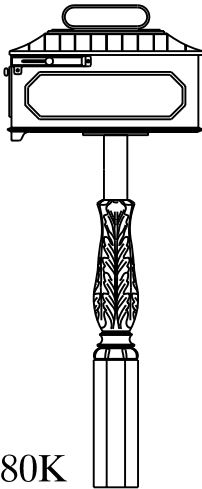

C3-2880K

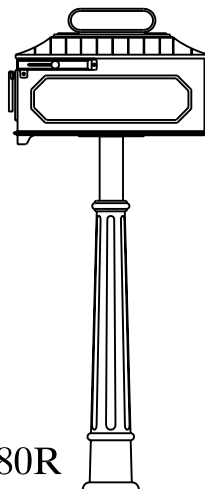

C3-3880R

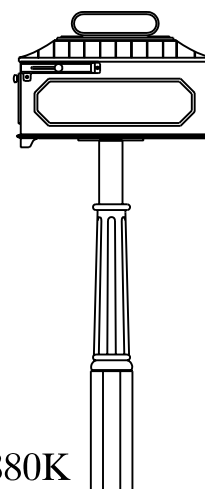

C3-5880K

ALSO AVAILABLE
IN A TWIN DESIGN

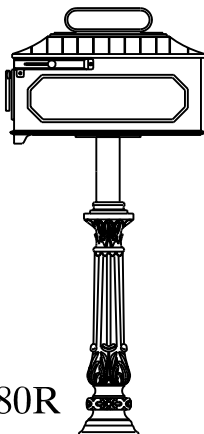

C3-6880R

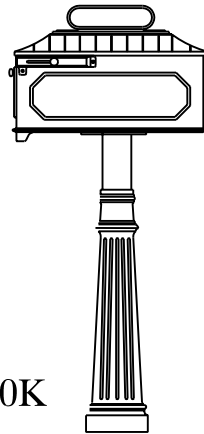

D3-8880K

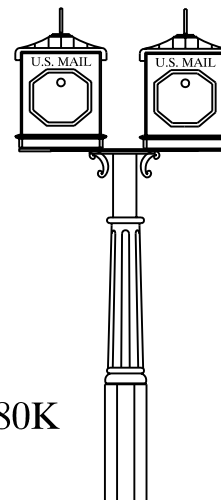

TC3-5880K



IMPERIAL MAILBOX SYSTEMS

M-SERIES SYSTEMS

SYSTEM CODE SPECIFICATION

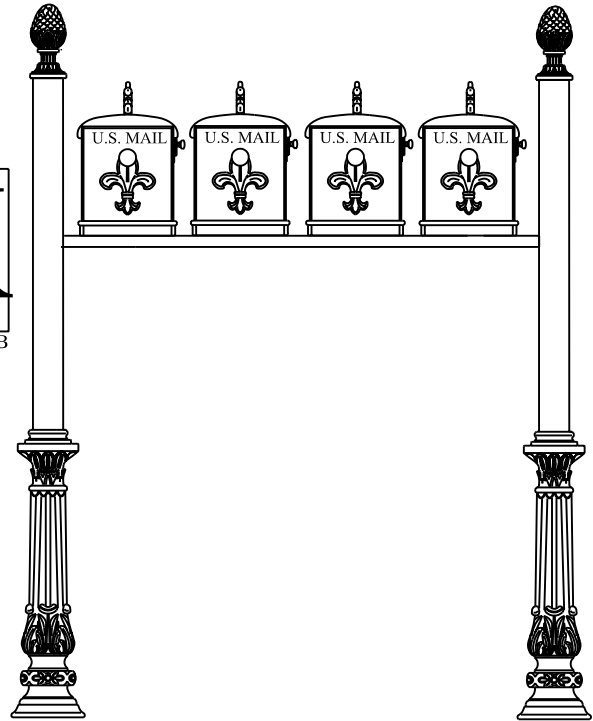
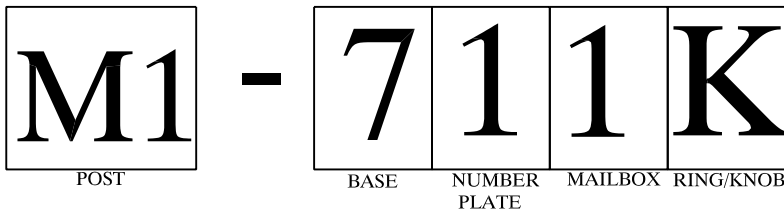

-M-SERIES SYSTEMS ARE AVAILABLE WITH CENTURY, ESTATE, OR WINDSOR POSTS.

-ALL IMPERIAL MAILBOXES AND NUMBER PLATES ARE AVAILABLE.

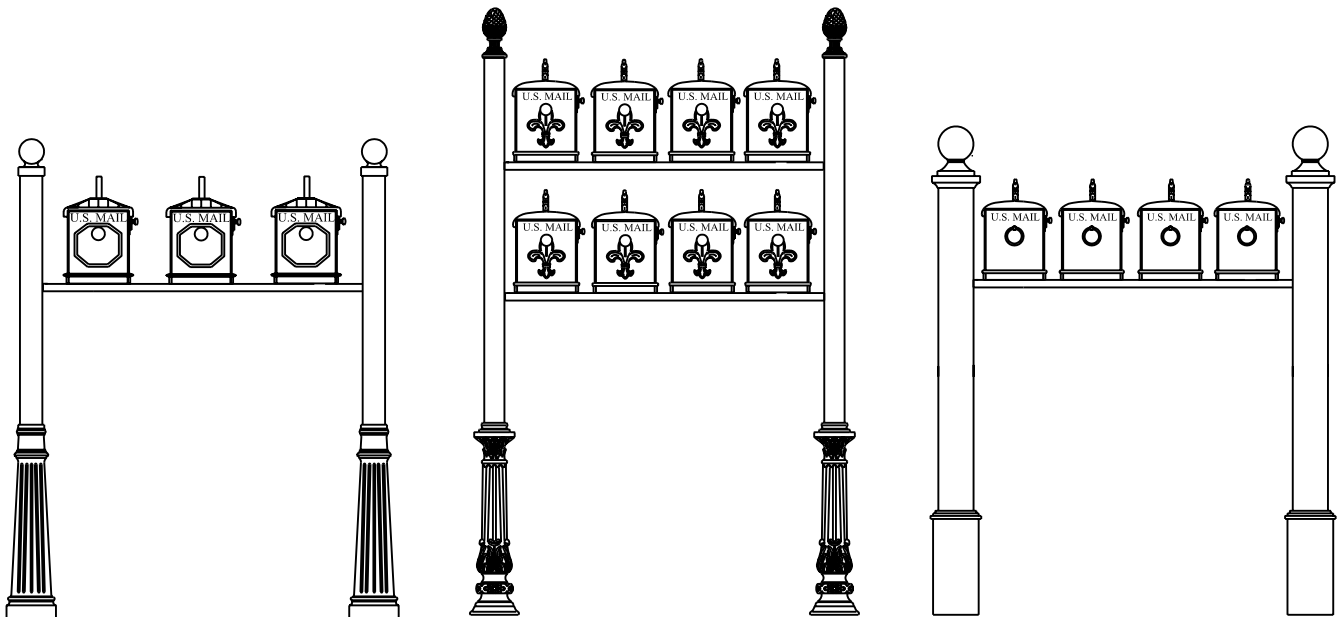

* Double shelf application must be approved by local Postmaster for delivery.

800-647-0777

FAX: 334-285-6635

www.imperialmailboxsystems.com



IMPERIAL MAILBOX SYSTEMS

DECORATIVE POSTS FOR CBU SYSTEMS

SYSTEM CODE SPECIFICATION

PST 6 CBU PM

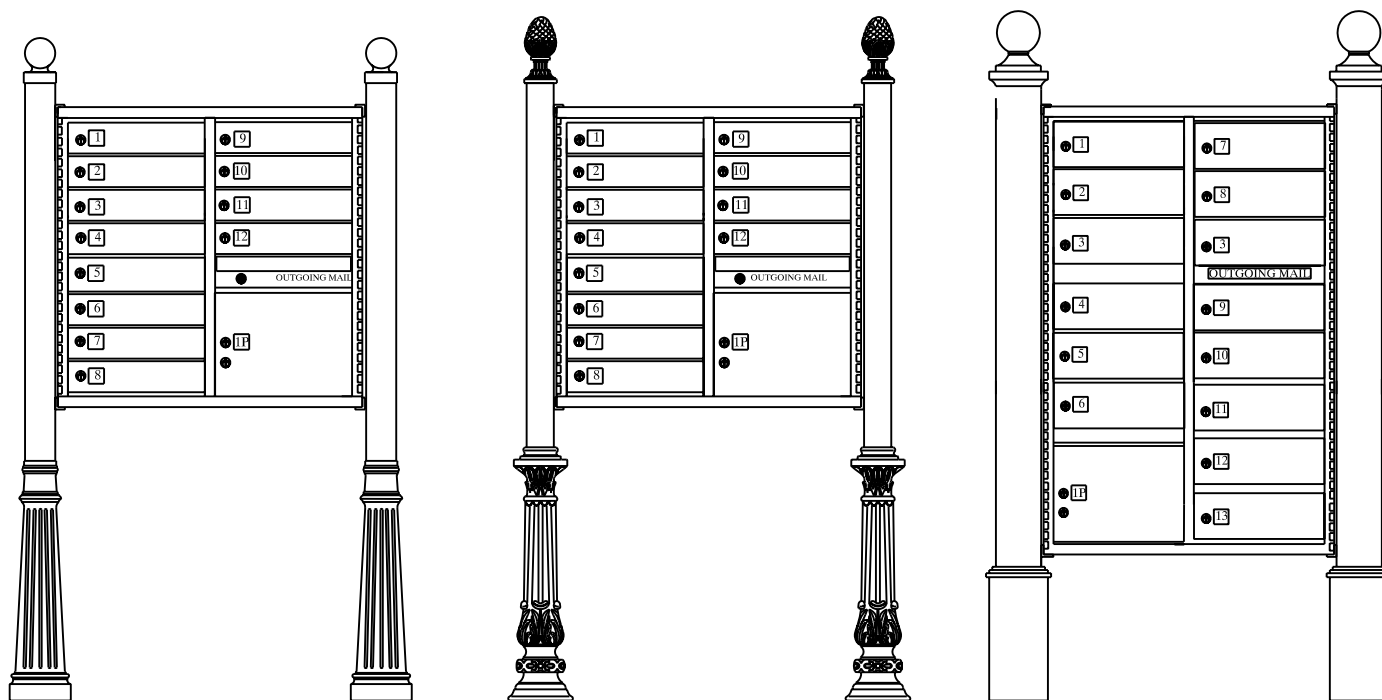

Decorative Posts for CBU Systems are available in Century, Estate, or Windsor Series.

Options Include Direct Ground Burial, or Pier-Mounted.