





Congratulations on the purchase of your Mail Boss™ locking security mailbox. The Mail Boss™ is designed with your security and convenience in mind. This mailbox is constructed of tough, vandal resistant, heavy gauge galvanized steel. Your Mail Boss™ mailbox comes with a unique **Fast-Trak™** mounting plate which makes installation fast and easy. This product can be installed on Epoch's matching in ground steel post or simply attached to most preexisting mailbox stands. The Mail Boss™ mailbox is designed with a large internal volume so that more than several days of mail can be securely stored inside. If this mailbox was purchased without a post and you desire to install this mailbox on a new color matched steel post, you may purchase one as well as other accessories at www.themailboss.com. Posts are shipped via standard ground service, but can be rush shipped for an additional fee.

On this insert you will find a list of hardware parts included as well as detailed instructions. Installation is quite simple and requires only a #2 phillips head screwdriver and a 13mm socket & ratchet, 13mm wrench or crescent wrench (note: If mounting onto an existing wood stand you will need a portable drill to drill four pilot holes). If you plan on installing an in ground post then additional tools may be needed. Installation will be most easily accomplished if you take the time to carefully sort the hardware and familiarize yourself with the function of each piece.

If you require assistance with assembly or part replacement, or for any other matter, contact the toll-free Epoch Design Service Center from anywhere in the Continental United States, Monday through Friday, 9AM - 5PM Pacific Standard Time at 1-800-589-7990. You may also email your request or comments to customerservice@themailboss.com and a service representative will respond. You will also find helpful hints and tips on our website: www.themailboss.com.

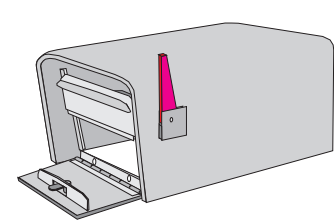
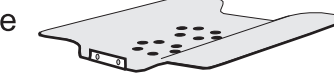
Thank you.

Parts and Hardware List

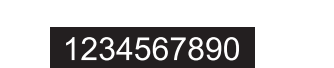
Quantity		Use
1 Mail Boss™ mailbox		Locking security mailbox.
1 Fast-Trak™ Mounting Plate		Used to provide easy and secure mounting of Mail Boss™
2 3/4" stainless machine bolt (#2 phillips head)		Use to attach Mail Boss™ to the Fast-Trak™ mounting plate
4 1 1/2" long lag screw (13mm head)		Use to connect mounting plate to a wooden mailbox platform
1 1/4" pilot hole drill bit		Used to drill pilot hole into existing wooden mailbox platform
3 Security key		Used to lock and unlock your Mail Boss™
3 Sheet reflective address numbers		

Patent pending **FAST-TRAK™** mounting plate makes installation easy. Fits almost any post or platform.

METAL POST

Attach **FAST-TRAK™** plate to metal post using four bolts.

- 1** Separate the mounting plate from the Mail Boss™ by removing the 2 machine screws located inside the locking door of Mail Boss™. Position the mounting plate so that the four pre-drilled holes in the post line up with the holes on the plate. Be sure the ear of the mounting plate is towards the front.

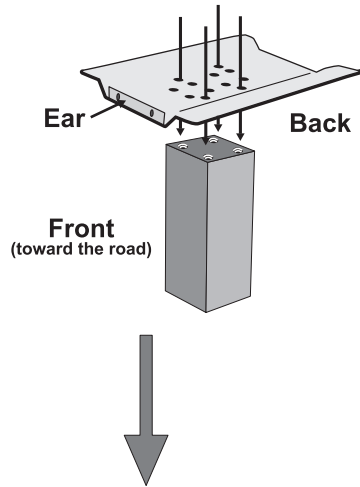

- 2** Attach the mounting plate to the post using the four machine bolts that came with the post. A drive socket, wrench or crescent wrench may be used to tighten and secure the bolts to the **Fast-Trak™** mounting plate.

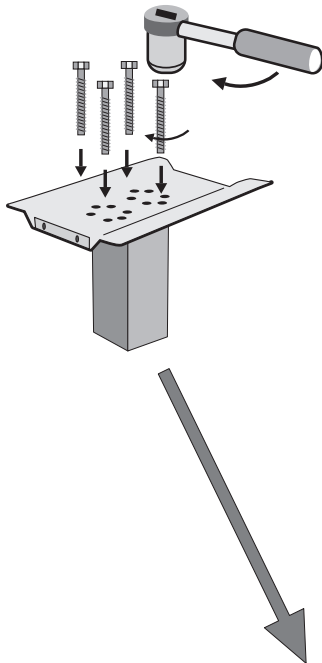

WOOD POST

Drill four pilot holes using drill bit provided and attach **FAST-TRAK™** plate with four lag screws provided.

- 1** Separate the mounting plate from the Mail Boss™ by removing the 2 machine screws located inside the locking door of Mail Boss™. Place the mounting plate so that it is centered over the wood platform. Be sure the ear of the mounting plate is towards the front. Position the ear of the mounting plate about 1" behind desired location of the front face of the Mail Boss™.

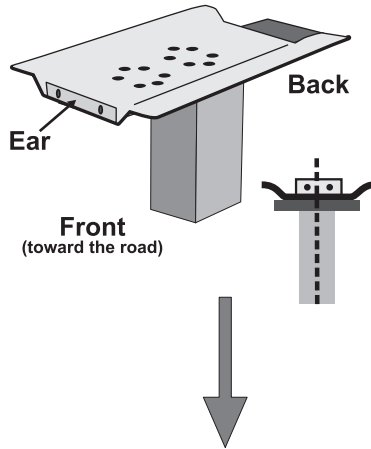

- 2** Choose four holes on the mounting plate that are furthest away from each other and yet are still on top of the wood platform. Mark their location on the wood. Using the drill bit provided, drill four pilot holes approximately 1 1/2" inches deep into the wood.

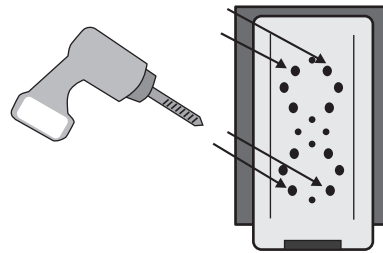

- 3** Attach the **Fast-Trak™** mounting plate to the platform using four 1 1/2" lag screws. A 13mm drive socket, 13mm wrench or crescent wrench may be used. Alternatively, the mounting plate has smaller holes which may be used for attachment with generic wood screws.

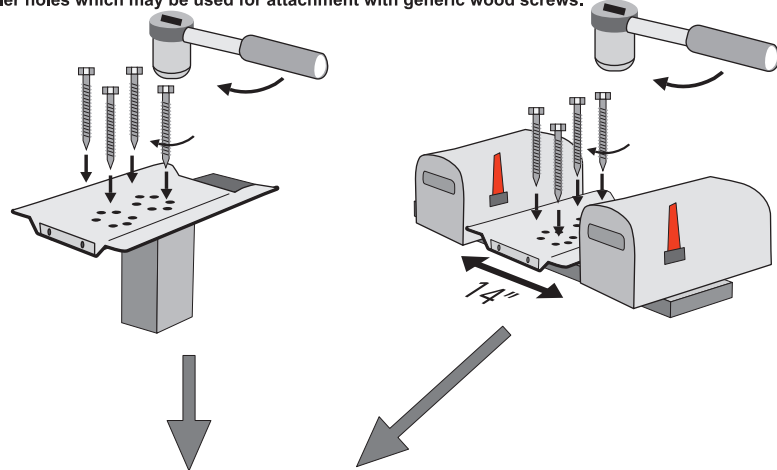

WOOD GANG PLANK

Drill four pilot holes using drill bit provided and attach **FAST-TRAK™** plate with four lag screws provided.

- 1** Separate the mounting plate from the Mail Boss™ by removing the 2 machine screws located inside the locking door of Mail Boss™. Locate a space on the plank approximately 14" wide. Place the mounting plate with equal spacing on the left and right side. Be sure the ear of the mounting plate is towards the front and is approximately 1" back from the front plane of adjacent mailboxes.

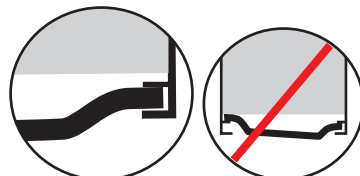
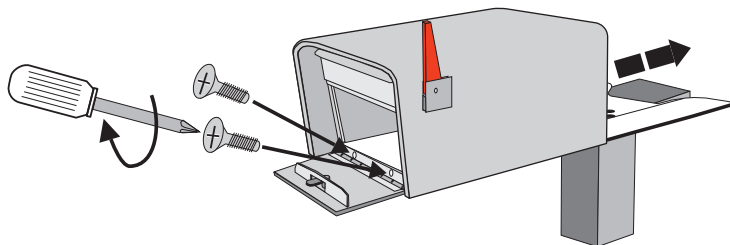
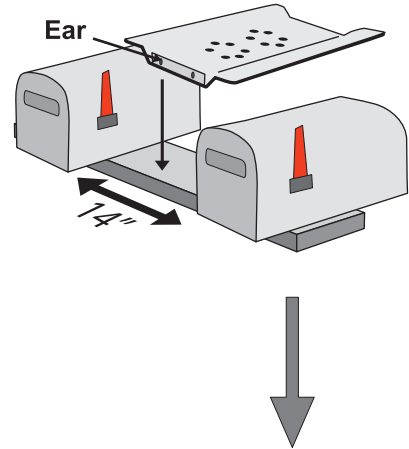

Simply slide MAIL BOSS onto FAST-TRAK™ mounting plate and secure with two machine screws provided.

MAIL BOSS™

Accessory items and parts available:
www.themailboss.com

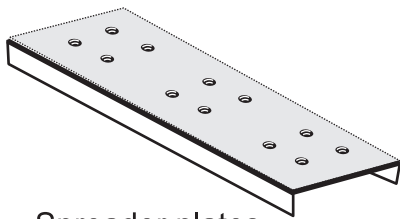

Spreader plates
Allows mounting of two, three
or four mailboxes on one post
Color matched

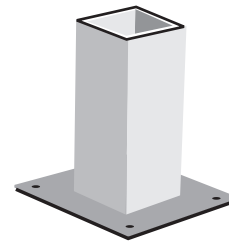

Base plate
For mounting applications onto
existing hard surfaces such as concrete
Color matched

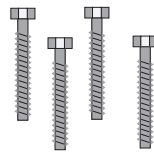

Attachment bolts for
Mail Boss™
steel post

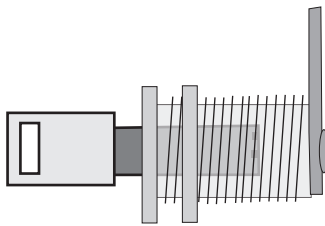

Medium security tube lock (standard)



Neodymium
magnet

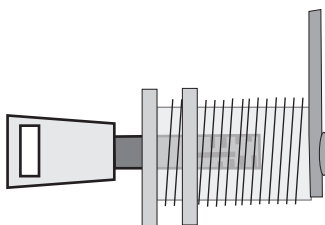

High security retained disk lock

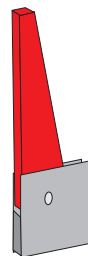

Replacement flag



Steel post
Color matched