

**140065 Dimensions**

Overall Width w/ Trim: 36-1/8"  
(Rough Opening: 33-7/8")

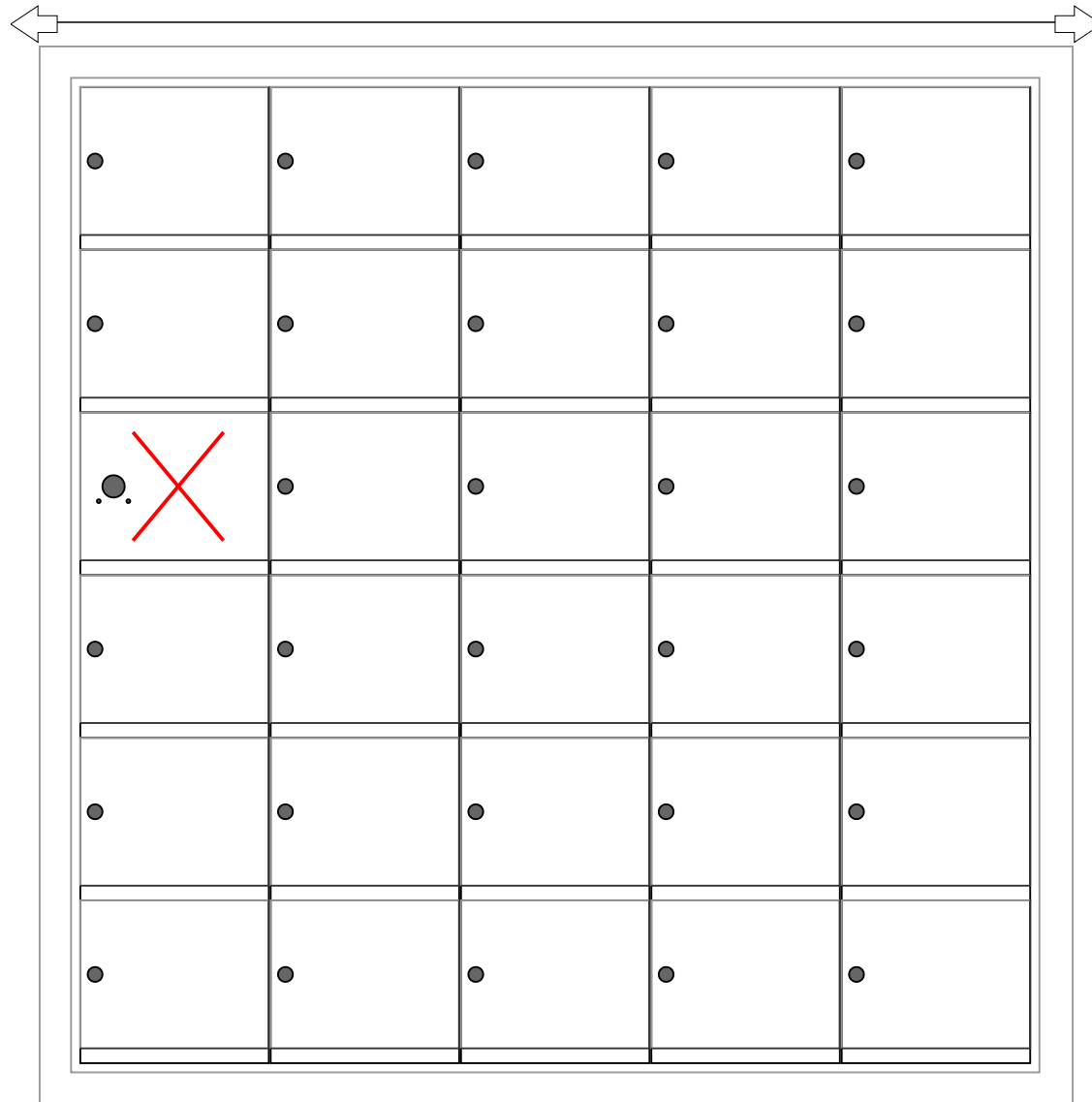

**140065**

**Side View**

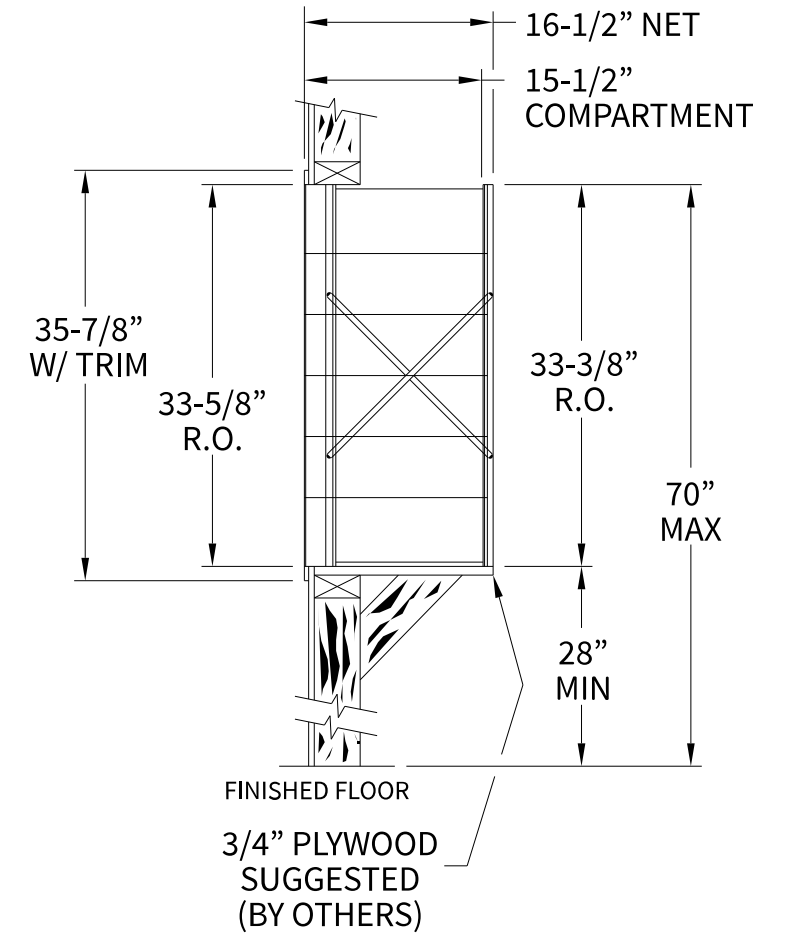

**Configuration Details:**

- 1. **Product Type:** 1400 Horizontal
- 2. **Installation:** Front-load, Recessed Mount
- 3. **Finish:** Anodized Aluminum
- 4. **Locks:** Standard Cam Lock, 2 keys
- 5. **Door Id:** tbd
- 6. **Master Door:** tbd

Matching standard snap-on trim included

**Models Used:**

(1) 140065

**DO NOT SCALE OFF DRAWING**

**Door Sizes Used:**

(29) 1400 1x1 Compartment  
(1) 1x1 Master

**ELEVATION:** 140065 | **MAILBOXES:** 29 |

**PROJECT NAME:** 1400 Series Mailbox

**DRAWN BY:** FLORENCE



1743 Quincy Ave. Suite 151  
Naperville, IL 60540  
800-824-9985  
www.MailboxWorks.com

**DATE:** 01-15-2016

**P.O. NO:**

**SCALE:** NONE

**QUOTE NO:**

**DRAWING NO.** WEB-1933

**SHEET 1 OF 1**