

140054 Dimensions

Overall Width w/ Trim: 29-3/4"
(Rough Opening: 27-1/2")

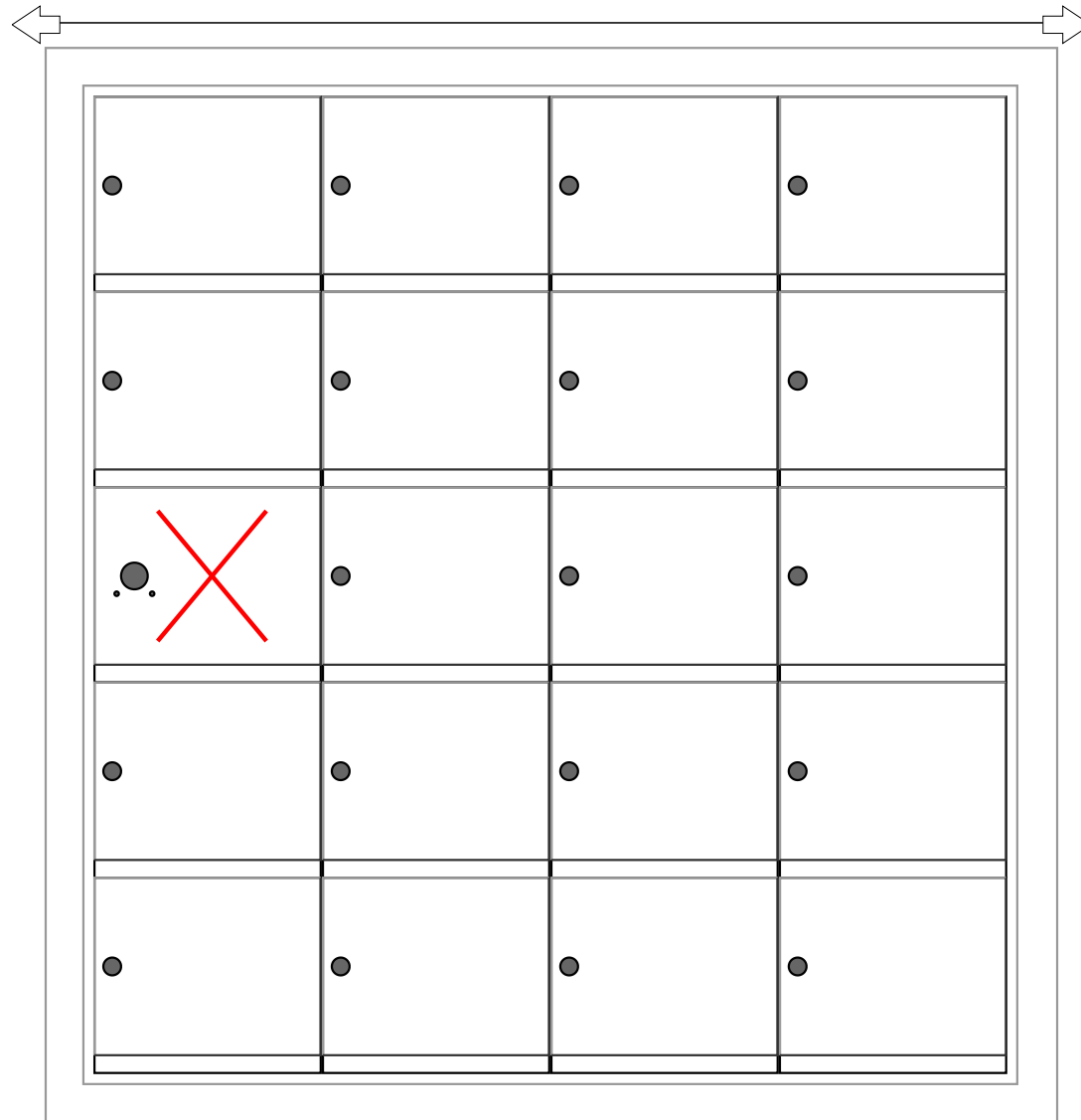

140054

Side View

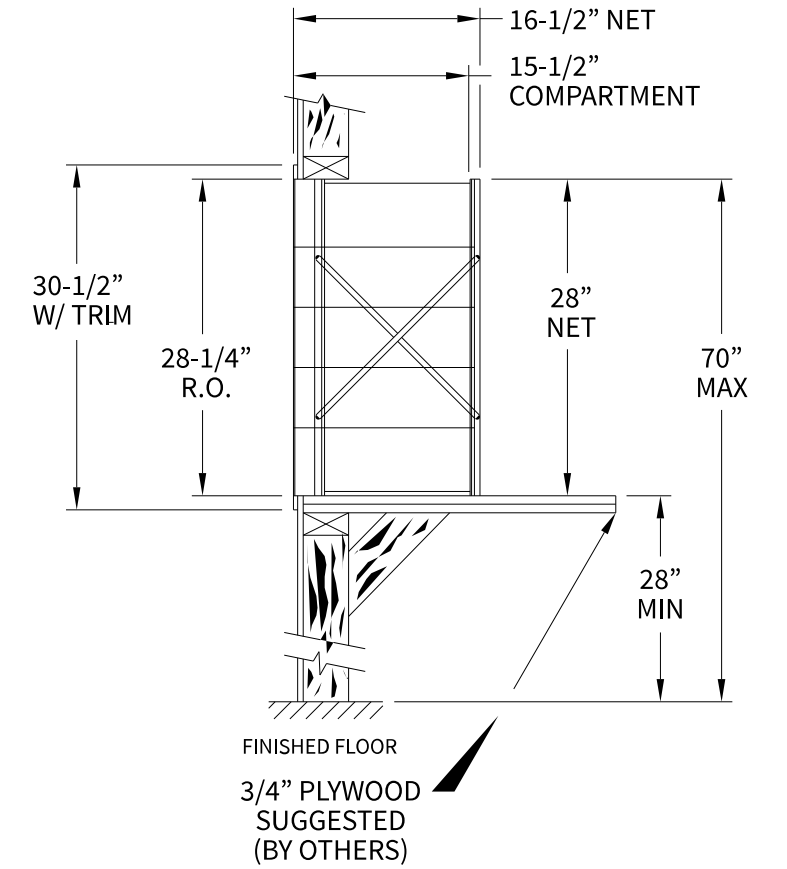

Configuration Details:

- 1. **Product Type:** 1400 Horizontal
- 2. **Installation:** Front-load, Recessed Mount
- 3. **Finish:** Anodized Aluminum
- 4. **Locks:** Standard Cam Lock, 2 keys
- 5. **Door Id:** tbd
- 6. **Master Door:** tbd

Matching standard snap-on trim included

Models Used:

(1) 140054

DO NOT SCALE OFF DRAWING

Door Sizes Used:

(19) 1400 1x1 Compartment
(1) 1x1 Master

ELEVATION: 140054 | **MAILBOXES:** 19 |

PROJECT NAME: 1400 Series Mailbox

DRAWN BY: FLORENCE



1743 Quincy Ave. Suite 151
Naperville, IL 60540
800-824-9985
www.MailboxWorks.com

DATE: 01-15-2016

P.O. NO:

SCALE: NONE

QUOTE NO:

DRAWING NO. WEB-1932

SHEET 1 OF 1